

HIDROMOTORJI MR

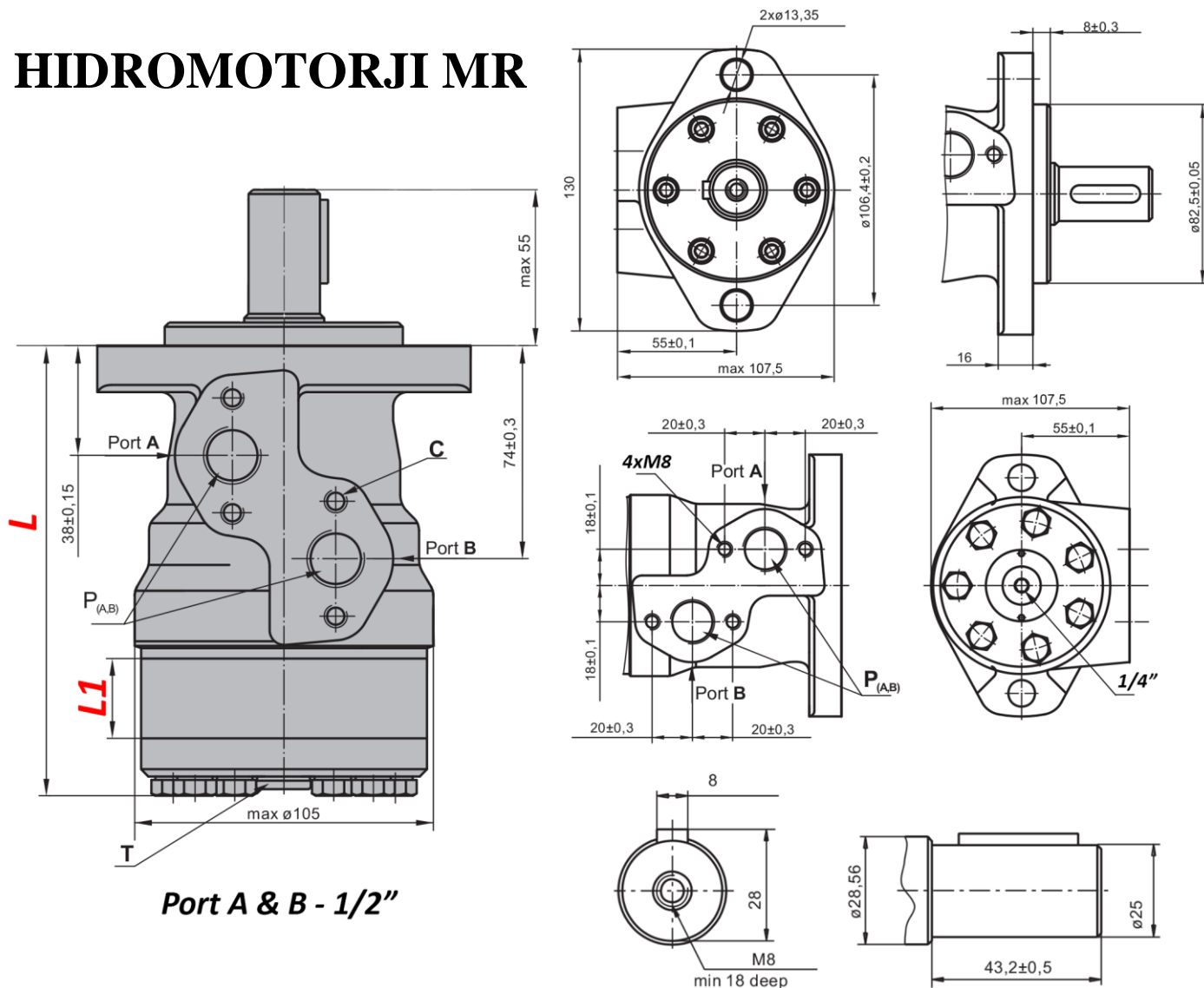

	L [mm]	L1 [mm]
MR 40	136,5	7,4
MR 50	135,5	6,67
MR 80	139,5	10,67
MR 100	142	13,33
MR 125	145,5	16,67
MR 160	150	21,33
MR 200	155,5	26,67
MR 250	162	33,33
MR 315	171,5	42,67
MR 400	182	53,33

		MR 50	MR 80	MR 100	MR 125	MR 160	MR 200	MR 250	MR 315	MR 400
cm/vrtljaji		51,5	80,3	99,8	125,7	159,6	199,8	250,1	315,7	397
Vrtljaji [rpm]	konstantni	775	750	600	475	375	300	240	190	150
	s prekinitvami	970	940	750	600	470	375	300	240	190
Navor [Nm]	konstantni	10	20	24	30	39	38,5	39	36	38
	s prekinitvami	13	22	28	34	43	46	47	47	47
	max.	17	27	32	37	46	56	60	61	61
Moč [kW]	konstantna	7	12,5	13	12,5	11,5	9	8	5	4,8
	s prekinitvami	8,5	15	15	14,5	14	12	9,5	8	6,8
Tlak [bar]	konstantni	140	175	175	175	175	140	110	85	65
	s prekinitvami	175	200	200	200	200	175	140	115	90
	max.	225	225	225	225	225	225	200	150	115
Pretok olja [L/min]	konstantni	60	60	60	60	60	60	60	60	60
	s prekinitvami	75	75	75	75	75	75	75	75	75
Priključni navoj		1/2"	1/2"	1/2"	1/2"	1/2"	1/2"	1/2"	1/2"	1/2"
Teža [kg]		6,8	6,9	7,2	7,3	7,5	8	8,4	9,1	9,8

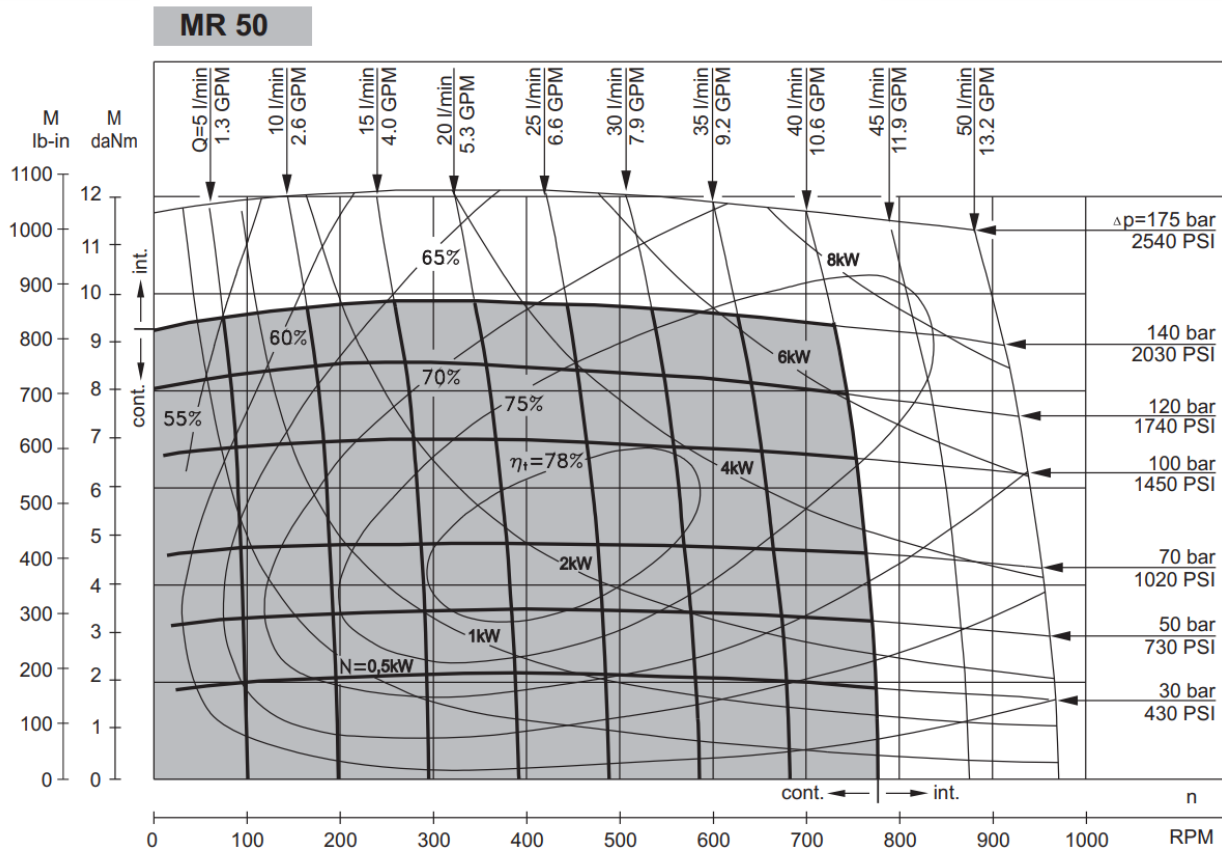

MR 80

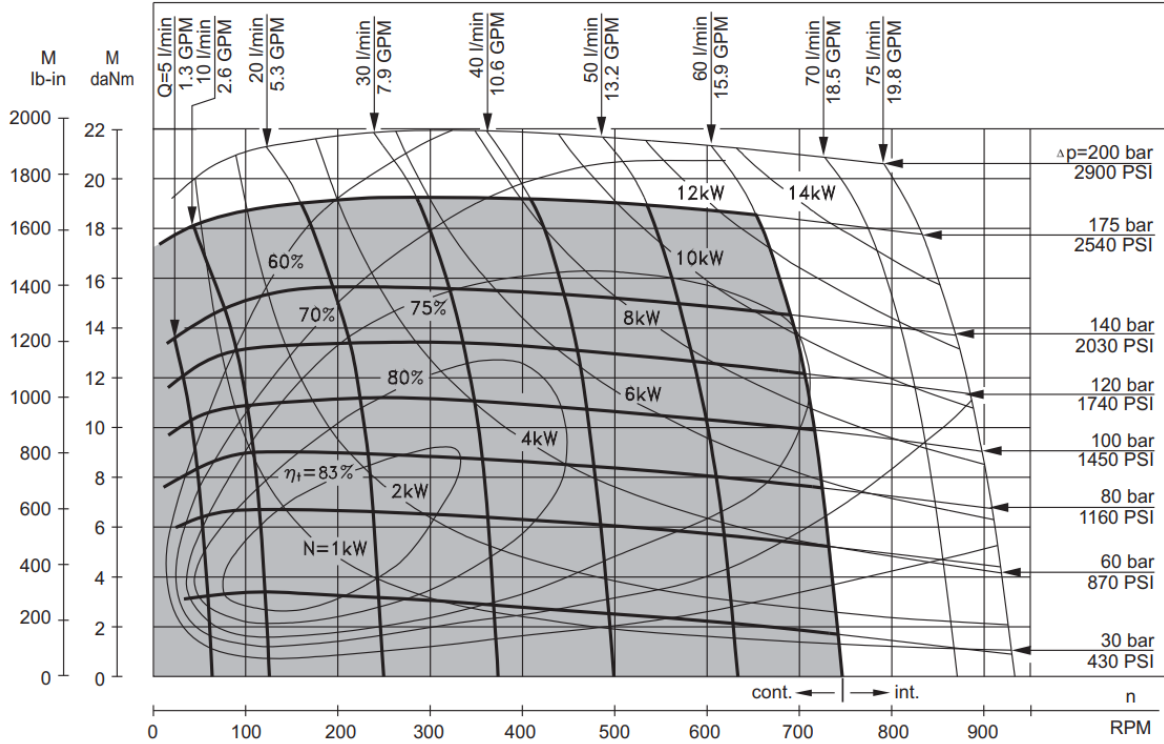

MR 100

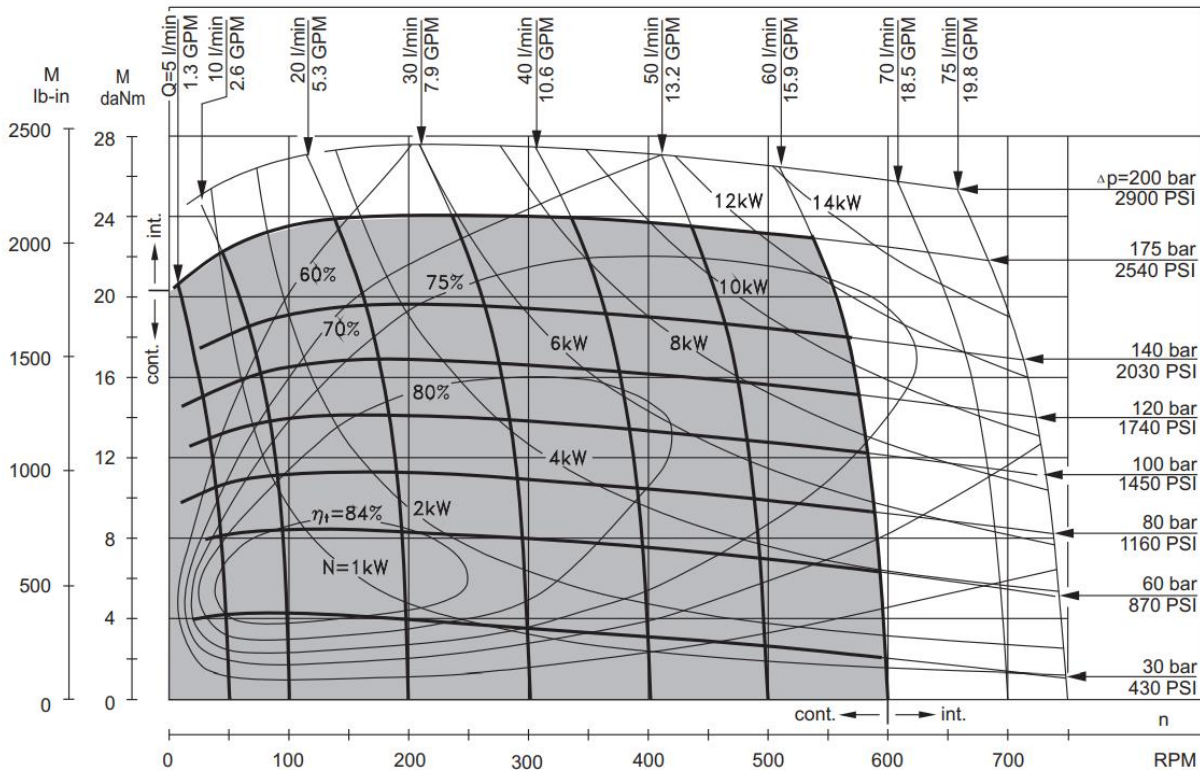

MR 125

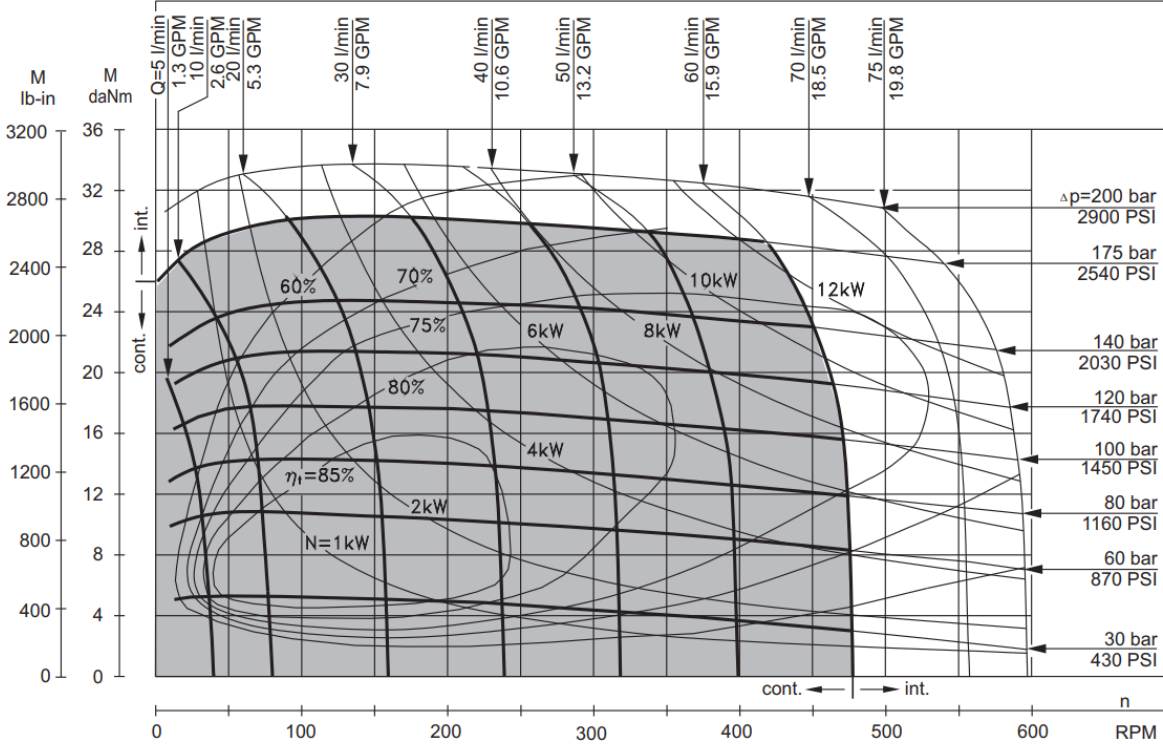

MR 160

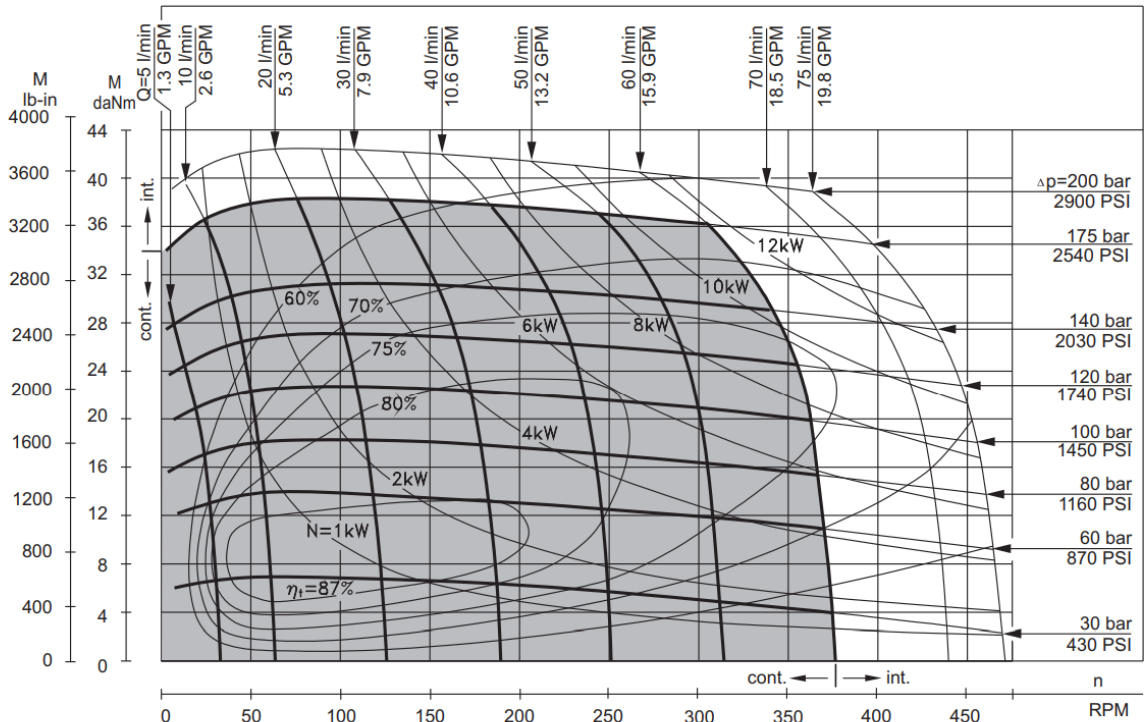

MR 200

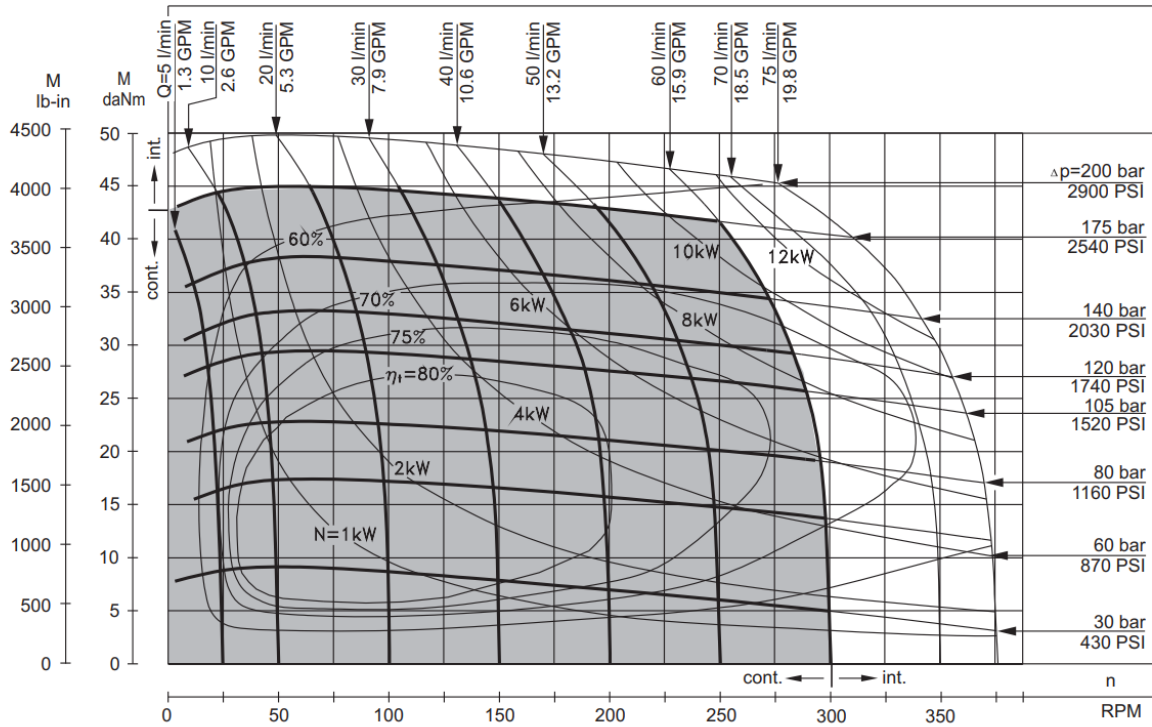

MR 250

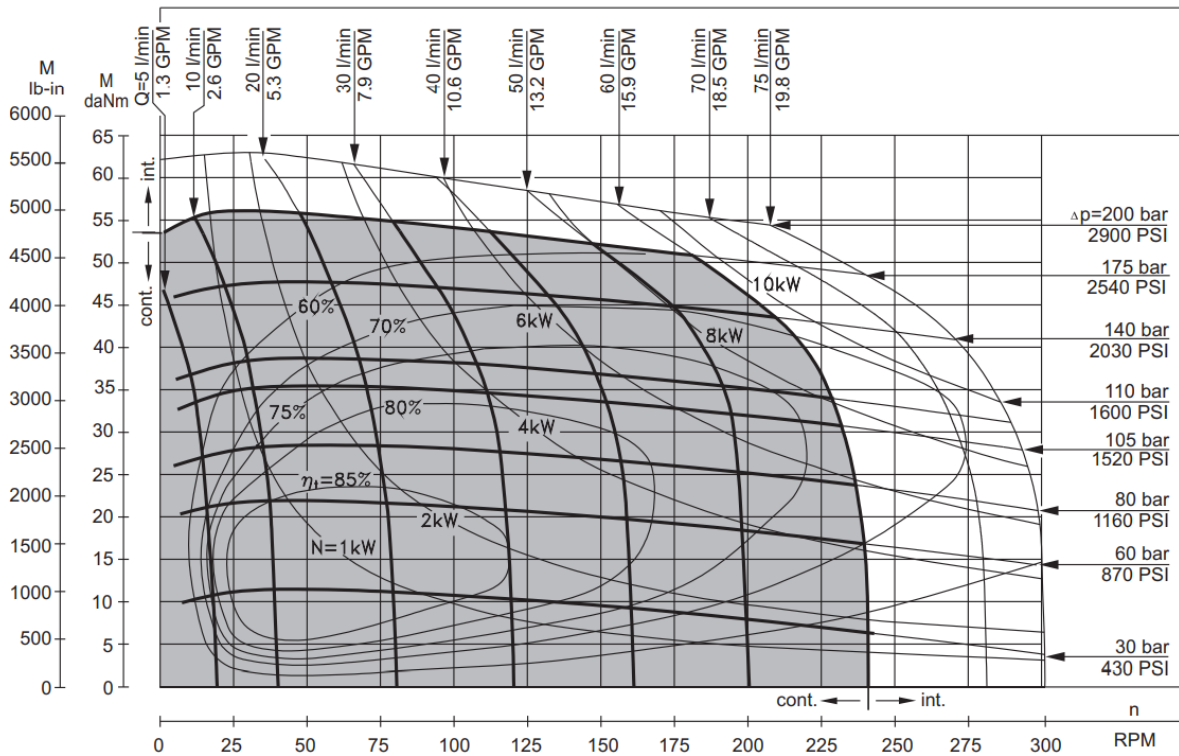

MR 315

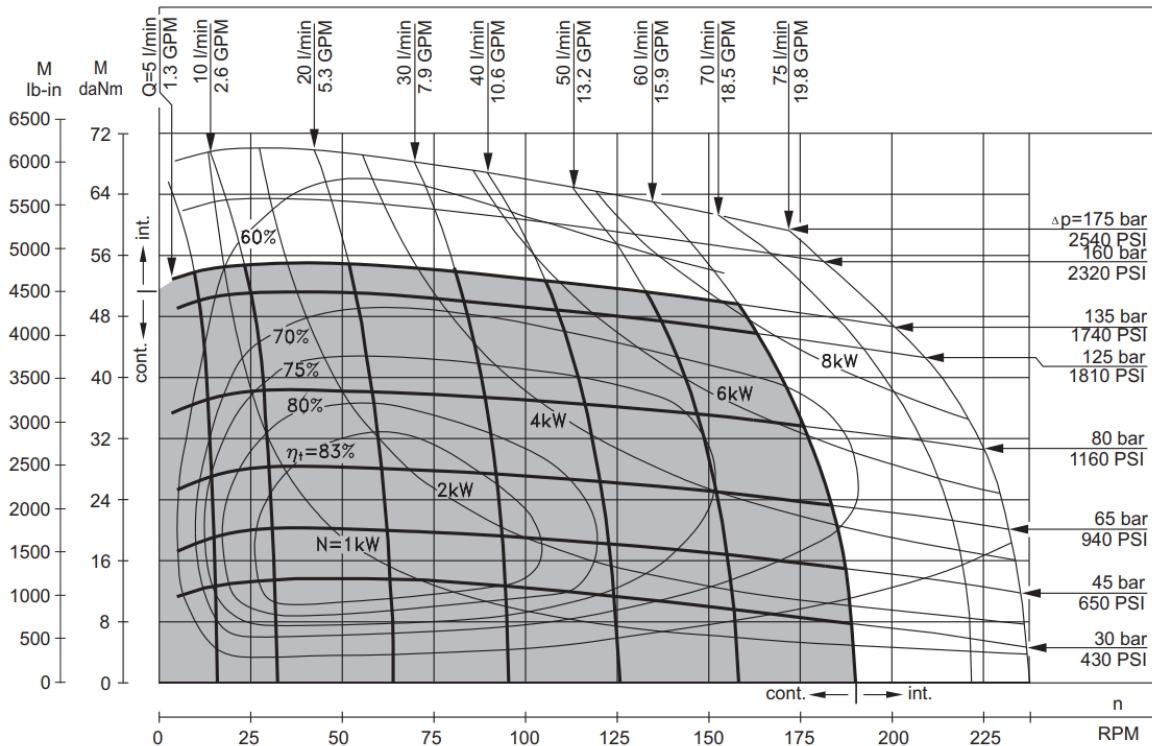

MR 400

